

## SeCorr 300



04.12.2015 a – 105732 – en

# Operating instructions

## **SeCorr 300**



04.12.2015 a – 105732 – en

# Operating instructions

# RT 300 radio transmitter – device setup

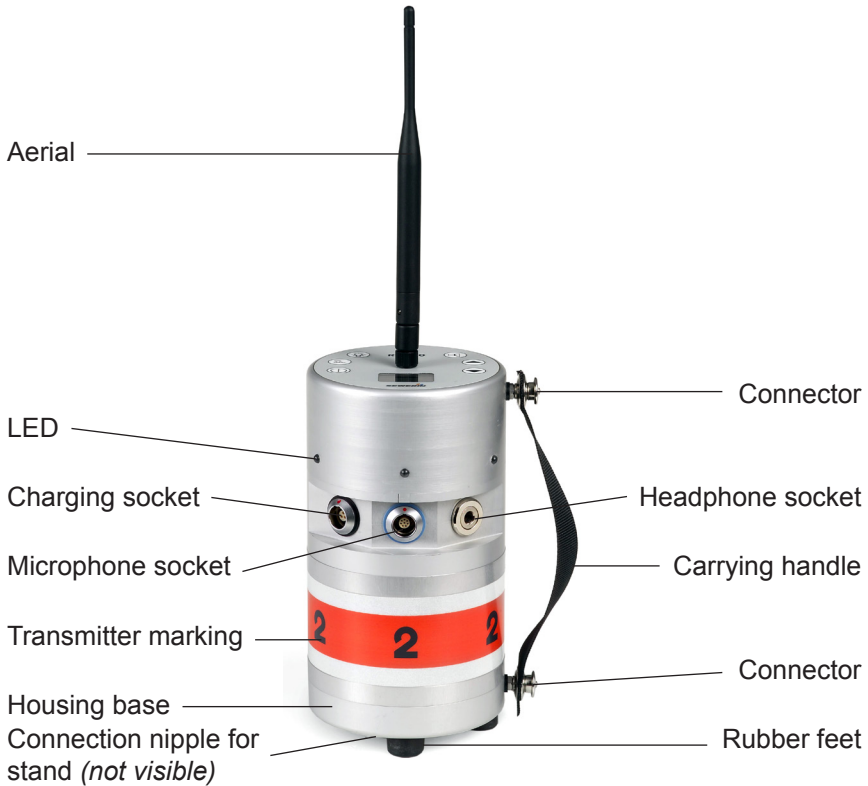

Fig. 1: RT 300 Radio Transmitter

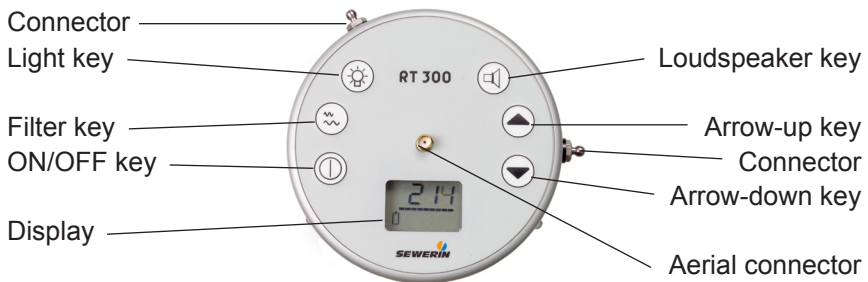
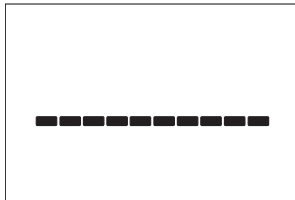

Fig. 2: RT 300 radio transmitter without aerial, view from top

## RT 300 radio transmitter – display



- Signal
- Version number
- Filter
- Charging time
- Battery type
- Error code



### Bar graph

- Volume
- Reception quality
- Charging



### Symbols, here:

- Battery symbol (full)
- Filter symbol
- Synchronisation symbol

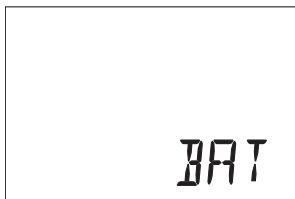

### Status message, here:

- **BAT** (Battery)

---

### Note:

You will find an overview of all symbols and status messages in section 10.2.

---

# Information about this document

Warnings and notes in this document mean the following:



**WARNING!**

Risk of personal injury. Could result in serious injury or death.

---



**CAUTION!**

Risk of personal injury. Could result in injury or pose a risk to health.

---

---

**NOTICE!**

Risk of damage to property.

---

---

**Note:**

Tips and important information.

---

Numbered lists (numbers, letters) are used for:

- Instructions that must be followed in a certain order

Lists with bullet points (point, dash) are used for:

- Lists
- Instructions that only involve one step

<b>1</b>	<b>Introduction .....</b>	<b>1</b>
<b>2</b>	<b>General .....</b>	<b>2</b>
2.1	Warranty .....	2
2.2	Intended use .....	3
2.3	Improper use .....	3
2.4	Safety information .....	4
<b>3</b>	<b>SeCorr 300 System (Overview) .....</b>	<b>6</b>
3.1	System components .....	6
3.2	Computer .....	7
3.3	Functional principle .....	8
<b>4</b>	<b>EM 350 Microphone /HY 300 Hydrophone .....</b>	<b>9</b>
4.1	Function .....	9
4.2	Ranges of use .....	9
<b>4.3</b>	<b>EM 350 microphone setup .....</b>	<b>9</b>
4.3.1	Microphone housing .....	10
4.3.2	Magnet .....	11
4.3.3	Cable .....	11
4.4	HY 300 hydrophone setup .....	12
<b>5</b>	<b>RT 300 Radio Transmitter .....</b>	<b>13</b>
5.1	Function and setup .....	13
5.1.1	Marking .....	13
5.1.2	Connections .....	14
5.1.3	LEDs .....	14
5.1.4	Keys .....	15
5.1.5	Display .....	15
5.2	Setup/mounting .....	15
5.3	Transport .....	16
5.4	Power supply .....	17
5.5	Changing the aerial .....	17
5.6	Operation .....	18
5.6.1	Switching on .....	18
5.6.2	Plugging in the microphone/hydrophone .....	19
5.6.3	Listening to noise .....	19
5.6.3.1	Adjusting the volume .....	20
5.6.3.2	Hearing protection function .....	20

5.6.3.3	Filtering noise.....	21
5.6.4	Replacing disposable/rechargeable batteries .....	23
5.6.4.1	Replacing the batteries .....	23
5.6.4.2	Setting the type .....	24
5.6.5	Charging the batteries.....	26
5.6.5.1	End of charging.....	27
5.6.5.2	Charging problems.....	27
5.6.5.3	Changing between charging and external power supply ..	28
5.6.6	Reception quality display .....	28
5.6.7	Synchronicity display.....	29
5.6.8	Switching on the light (display and microphone).....	29
<b>6</b>	<b>RX 300 Radio Receiver .....</b>	<b>30</b>
6.1	Function and setup.....	30
6.1.1	LED .....	31
6.2	Setup/mounting .....	31
6.3	Power supply.....	32
6.4	Changing the aerial .....	32
6.5	Advice for use .....	32
<b>7</b>	<b>Stand .....</b>	<b>33</b>
<b>8</b>	<b>Performing a Correlation Measurement.....</b>	<b>34</b>
8.1	Suitable measurement locations .....	34
8.2	Requirements .....	34
8.2.1	Equipment.....	34
8.2.2	Required data.....	35
8.3	Setting up the measuring section.....	35
<b>9</b>	<b>Troubleshooting .....</b>	<b>38</b>
9.1	Problems with the RT 300 .....	38
9.1.1	Device not ready for use .....	38
9.1.2	Status messages during the charging process .....	38
9.1.3	Error codes.....	38
9.2	Problems with the RX 300.....	40
9.3	Problems with the RX 300 – RT 300 radio connection.....	40

<b>10</b>	<b>Appendix.....</b>	<b>41</b>
10.1	Specifications and permitted operating conditions.....	41
10.1.1	RT 300 radio transmitter.....	41
10.1.2	RX 300 radio receiver.....	44
10.1.3	EM 350 microphone.....	45
10.1.4	HY 300 hydrophone.....	46
10.1.5	Stand for RT 300.....	47
10.1.6	SeCorr 300 software.....	47
10.1.7	SeCorr 300 system (system features).....	47
10.2	RT 300 display.....	48
10.2.1	Symbols.....	48
10.2.2	Status messages.....	48
10.3	Accessories.....	49
<b>11</b>	<b>Index.....</b>	<b>50</b>



# 1 Introduction

The **SeCorr 300** system is used to detect leaks in underground pressure line systems, such as water pipes, with the help of a computer. It uses the correlation principle and features continuous digital signal processing and options to manually filter out noise.

The **SeCorr 300** can be used to detect leaks in both metal and plastic piping.

All the data recorded is cached in the **RT 300** radio transmitter. The advantage of this is

- the data does not have to be analysed directly at the measurement location, rather this can be done at a later stage,
- data can be recorded for a virtually infinite measuring section.

The **SeCorr 300** system can also be used to detect leaks by means of multi-point correlation.

## 2 General

### 2.1 Warranty

The following instructions must be complied with in order for any warranty to be applicable regarding functionality and safe operation of this equipment.

Hermann Sewerin GmbH accepts no liability for any damages resulting from non-compliance with these instructions. The warranty and liability provisions of the terms of sale and delivery of Hermann Sewerin GmbH are not affected by the information given below.

- This product must only be operated after the relevant operating instructions have been read and understood.
- This product must only be used for its intended purpose.
- This product is only suitable for use in industrial and commercial applications.
- Repairs must only be carried out by a specialist technician or by other suitably trained personnel.
- Changes or modifications must not be made to this product without approval from Hermann Sewerin GmbH. The manufacturer cannot be held responsible for damages if unapproved modifications have been made.
- Only accessories supplied by Hermann Sewerin GmbH may be used with this product.
- All repairs must be carried out using replacement parts that have been approved by Hermann Sewerin GmbH.
- Only approved aerials may be used.
- The manufacturer reserves the right to make technical modifications in the course of further development.

Generally applicable safety and accident prevention regulations must be complied with, in addition to the information provided in this manual.

## 2.2 Intended use

**SeCorr 300** is a system for recording and analysing noises. It is used to detect leaks in **brimming** pressure line systems (e.g. water pipe networks). The system can be used for both metal and non-metal pipe networks.

**SeCorr 300** must only be operated by suitably qualified employees (skilled staff, specialists and technicians) from supply companies.

All applicable safety and accident prevention regulations must be complied with when using the **SeCorr 300** system and its components.

Detailed information on appropriate operating conditions for the components of the **SeCorr 300** system at the place of installation are provided in section 10.1.

All components used in the **SeCorr 300** system have been manufactured in accordance with all binding legal and safety regulations. All components used correspond to the state-of-the-art and conform to EC requirements. The system is safe to operate when used in accordance with the instructions provided.

Careless or improper use of any of the system components may, however, present a risk of damage or harm to persons or property.

## 2.3 Improper use

Any use of the system or its components that does not comply with the description in section 2.2. shall be deemed to be improper use.

The manufacturer accepts no responsibility for any damage or harm caused to persons or property as a result of improper use.

## 2.4 Safety information

These operating instructions must be read carefully and in full. All advice given in these operating instructions must be followed.

- All applicable accident prevention regulations must be observed.
- Do not carry out any modifications to the **SeCorr 300** or otherwise change or tamper with it in any way. Never open an **RT 300, RX 300, EM 350** or **HY 300** device (the only exception is when changing the battery on the **RT 300**). Failure to observe the above instructions will invalidate the warranty.
- Ensure that no dirt or moisture gets into the connections on the appliances (sockets, aerial connections, connection nipples).
- Observe the temperature ranges in which the devices may be used and stored (see section 10.1).
- Always adequately secure the setup locations of the **SeCorr 300** components to prevent injury to persons and damage to vehicles.

### Aerials

It is important that the aerials of the **RT 300** and **RX 300** do not get damaged.

- Never carry a unit by its aerial.
- Never bend, kink or cut the aerial.

Only use SEWERIN-approved replacement aerials and aerial attachments.

### **Specials features of the RT300 radio transmitter**

- The **RT 300** is splash-proof to IP64. The device must therefore not be immersed in liquids or exposed to water jets.
- It is essential to read section 5.6.4. before attempting to replace batteries. Failure to observe the instructions provided may result in injury to the user and/or damage to the **RT 300** unit.

### **Special features of the RX 300 radio receiver**

- The **RX 300** must not be connected to powered USBs.

## 3 SeCorr 300 System (Overview)

### 3.1 System components

The **SeCorr 300** system comprises:

- **EM 350 microphone**, for short: **EM 350** (see section 4)  
or  
**HY 300 hydrophone**, for short: **HY 300** (see section 4)  
for recording the noises at the measurement location
- **RT 300 radio transmitter**, for short: **RT 300** (see section 5)  
for caching the data;  
for sending the data to the receiver
- **RX 300 radio receiver**, for short: **RX 300** (see section 6)  
for receiving the data from the transmitter;  
for relaying the data to the computer
- **Stand**  
for correct positioning of the **RT 300** during the measurement
- **SeCorr 300 software**  
for analysing the measurements

The **SeCorr 300 software** is described in separate operating instructions.

#### Accessories

There are various optional accessories available for the **SeCorr 300** system (see section 10.3). The user may find the following parts particularly useful when performing a measurement:

- **Case**  
for transporting and storing the system components
- **Cover hammer**  
for easier opening of manhole covers
- **Headphones**  
for listening to the noise on the **RT 300**

### 3.2 Computer

A computer is required for analysing the measurement using the **SeCorr 300 software**. Various computer types are suitable.

Computer	Preferred range of use	Remark
<b>PC</b> e.g. desktop computer	stationary; fixed installation in a service vehicle	standard
<b>Notebook</b>	mobile	standard; must be protected against effects of weather and damage in transit
<b>Notebook</b> e.g. microport colibri	mobile	weather-proof

#### System requirements

- Operating system: Microsoft Windows 7 or higher  
32/64 bit
- RAM: at least 2 GB
- Processor: 1.2 GHz (recommended 1.8 GHz)
- Features: USB port 1.1 or higher  
Sound card with headphone jack
- Screen resolution: 1024 × 768 pixels

### 3.3 Functional principle

**SeCorr 300** uses the correlation principle to detect leaks.

Each leak produces a noise which is different to the background noise in the pipe system. It spreads in both directions along the pipe at a certain speed (depending on the sound velocity of the pipe material). This leak noise is recorded by two **microphones** at two different measurement locations along the measuring section and immediately digitised. The data is recorded in **radio transmitter RT 300** and from there it is sent to **radio receiver RX 300**

The receiver relays the data to the **computer**, which determines the position of the leak using the **SeCorr 300 software**. The following is used for the calculation:

- the time difference of the sound between measurement locations different distances away
- other measurement data (e.g. length of the measuring section, sound velocity)

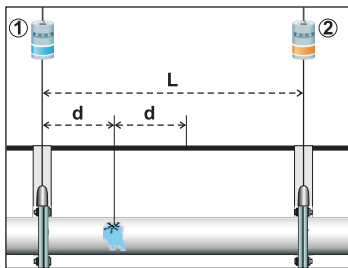

$$d = \frac{L - v \Delta t}{2}$$

- ① ② Measurement location (transmitter)
- L Length of the pipeline
- d Distance of the leak from ①
- $\Delta t$  Time difference
- v Sound velocity

Fig. 3: Principle for determining the leak position

---

#### Note:

**SeCorr 300** is used to determine the position of a source of noise. The user must always decide whether the noise actually stems from a leak or is caused by something else.

---



## 4 EM 350 Microphone /HY 300 Hydrophone

### 4.1 Function

The **EM 350** and **HY 300** record noises at the measurement location. The data is digitised immediately and relayed to the transmitter.

### 4.2 Ranges of use

The **EM 350** is a universal microphone. It is equally well suited for use in metal pipes and non-metal pipes. The **EM 350** can be attached to the measurement location by means of a magnet or adapter.

The **HY 300** can also be used for measurements on both metal and non-metal pipes. It is particularly well suited for correlation measurements over large distances and for large pipe diameters. In contrast to the **EM 350**, the **HY 300** records noises directly from the water column. To do so, it must be screwed to a hydrant, for example.



#### **CAUTION!**

Use the **HY 300** for measurements in drinking water networks only.

---

Refer to section 8.2 for detailed information on suitable measurement locations.

### 4.3 EM 350 microphone setup

The **EM 350** comprises:

- Microphone housing
- Magnet (round or horseshoe magnet)
- Special cable with jack for connecting to **RT 300**



### **WARNING!**

The magnet is very powerful.

- Persons with a pacemaker should not go near the **EM 350** microphone.
  - The magnet must be kept away from electronic storage media (diskettes, hard drives, credit cards, etc.), monitors (PC, TV) and clocks.
- 



Fig. 4: **EM 350 microphone** with round magnet (left) or horseshoe magnet (right)

---

### **NOTICE!**

The piezo components and the **EM 350** magnet are fragile.

- Never drop the microphone.
- 

#### **4.3.1 Microphone housing**

The front of the housing features:

- Thread to screw in the magnet
- Two LEDs to illuminate the shaft when lowering the microphone

The LEDs are switched on via the **RT 300** (see section 5.6.8).

---

#### **Note:**

The housing rattles when it is moved backwards and forwards. This is due to the design of the device and is not a fault.

---

### 4.3.2 Magnet

The magnet is removable and interchangeable. It comes in two models:

- **Round magnet** for flat surfaces, e.g. square gate end
- **Horseshoe magnet** for curves e.g. pipes

The magnetic force of each model is approx. 10 kg.

The **round magnet** comes with an extra **metal disc**. This reduces the magnetic force and thus protects other devices (e.g. notebooks) from the strong magnetic effect. Nevertheless, you should keep the magnet away from other magnetic storage media.

Retain the metal disc and always use it when the round magnet is not in use. The **cardboard disc** between the magnet and the metal disc is to help you remove the magnetic disc.

### 4.3.3 Cable

The cable is used to:

- lower the microphone into the shaft and lift it out again after the measurement
- transmit data to the transmitter

---

#### Note:

The cable is designed to withstand any tractive forces that may occur when lowering/lifting the microphone.

---

The **jack** at the free end of the cable is marked blue and mechanically coded. It can only be connected to the **microphone socket** of the **RT 300**.

#### 4.4 HY 300 hydrophone setup

The **HY 300** comprises only the hydrophone housing. In contrast to the **EM 350**, the connection cable to the **RT 300** is not permanently attached to the hydrophone.

##### Hydrophone housing

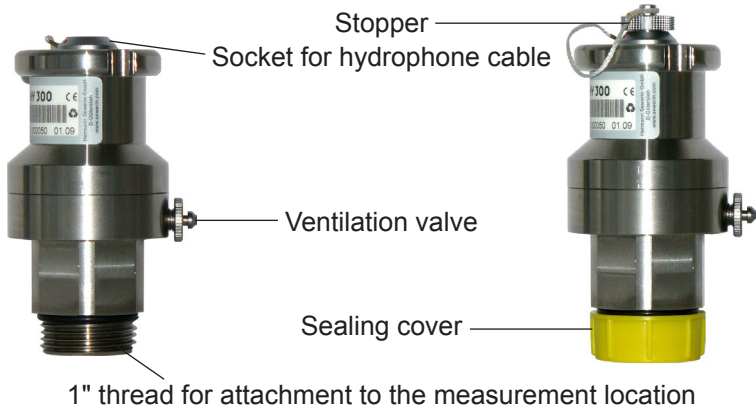

Fig. 5: **HY 300 hydrophone** without stopper and sealing cover (left) and with stopper and sealing cover (right)

---

##### Note:

Protect the **HY 300** from moisture and dirt when not in use by sealing the socket with the stopper and the thread with the sealing cover.

---

##### Hydrophone cable

The cable is used to transfer data to the transmitter. The jacks on the cable are marked blue and mechanically coded. They can only be connected to the microphone socket of the **RT 300**.

## 5 RT 300 Radio Transmitter

### 5.1 Function and setup

The **RT300 radio transmitter** takes the digitised data from the microphone and saves it in "data packets" (stack memory). These "data packets" are ready for retrieval by the receiver. Data which has been successfully retrieved from the **RT 300** memory is deleted.

The **RT 300** acts like a relay station. It can also be used independently of the **SeCorr 300** to listen to noises (microphone **EM 350** or hydrophone **HY 300** required).

You will find an overview and all the part names of the **RT 300** in the front cover (figs. 1 and 2).

#### 5.1.1 Marking

The appliances have colour markings.

- **Transmitter 1: blue**
- **Transmitter 2: orange**

It is important to be able to tell the difference between the transmitters because at least two **RT 300s** have to be used for a measurement and there must be no mix-ups during analysis.

---

#### **Note:**

The **SeCorr 300 software** uses the same transmitter colour and number allocation.

---

### 5.1.2 Connections

The sockets on the **RT 300** are colour coded and mechanically coded. This means that only the right cable can be connected.

Connection	Colour coding
Charging socket	black
Microphone socket	blue
Headphone socket	colourless

Please ensure when plugging in the jacks that the **red markers** on the jack and the socket are **congruent**.

---

#### NOTICE!

- Do not use force when plugging the jacks into the sockets.
  - If necessary, check whether the jack – socket allocation is correct (same colour coding) and the jacks are correctly aligned (red dot).
- 

### 5.1.3 LEDs

Six LEDs are fitted in the housing of the **RT 300** above the sockets. The LEDs flash red.

Flash rate	Number of LEDs	Description
Constant alternation: fast rotating (0.2s) – break (2.2s)	6	Transmitter ready
Light permanently on for 3s	6	Transmitters have been synchronised
Every 2 s	2 (opposite)	Battery charging
Constant alternation: short double flashing – break	2 (opposite)	Charging complete (Conservation charging)

The LEDs also serve to make pedestrians and vehicles aware of the erected device by flashing (**warning function**).

#### 5.1.4 Keys

You will find an overview with the names of the keys inside the front cover (fig. 2). The function of the keys is explained in section 5.6.

#### 5.1.5 Display

The display features a backlight (see section 5.6.8). The symbols and status messages are explained in section 10.2.

### 5.2 Setup/mounting

**When performing a measurement the transmitter must always be mounted on the stand.**

1. Set up the stand
2. Push the connection nipple (on the base of the device) onto the quick-connect on the stand.

The quick-connect must be pulled down to release the device from the stand.

The device stands securely on three rubber feet when not being used for measurement.

### 5.3 Transport

Each **RT 300** features a flexible carrying handle. It can be attached to two of the three connectors available.



Fig. 6: Carrying handle attached to **RT 300** lengthways (left) or crossways (right)



## 5.4 Power supply

The **RT 300** can either be operated with:

- rechargeable NiMH batteries (as delivered)
- disposable alkaline batteries
- external AC/DC adapter

### Batteries

Always use **four battery cells of the same type**. More details about the battery types can be found in section 10.1.1.

It is advisable to switch the unit off when not in use to extend the operating time when the device is powered by batteries.

Please note the following important points:

- As soon as the batteries need replaced/recharged, the **battery symbol** on the display will begin to **flash**.
- The **RT 300** cannot store any further data once the batteries are empty.

---

### Note:

Check the condition of the batteries **before each measurement**. Replace/recharge the batteries in good time.

---

## 5.5 Changing the aerial

The aerial is fitted to the device with a screwed joint. Please note when changing the aerial:

- The screwed joint must always be **clean and dry**.
- **Hand-tighten** the aerial. Do not use any tools to tighten it.

Note: The aerials of the **RT 300** and **RX 300** are identical.

## 5.6 Operation

### 5.6.1 Switching on

- Hold down the ON/OFF button until the start screen appears.



The following information will be displayed:

- Version number, *here*: 2.03
- Battery symbol
- Type of power supply, *here*: **ACU** (rechargeable battery)

- Wait a moment.

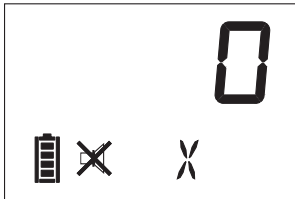

The device is **ready for use**.

- There will be no signal until the microphone/hydrophone is connected.

- Synchronisation symbol

Flashes until the transmitters are synchronised.

Not visible when the transmitters are synchronised (**measuring mode**).

- *Here*: headphones switched off

### Battery symbol

The number of segments in the battery symbol represents the remaining battery capacity / remaining charge. If the batteries need replaced/recharged, the battery symbol flashes.

---

#### Note:

You must press the ON/OFF key again to turn the device off.

---

### 5.6.2 Plugging in the microphone/hydrophone

The transmitter automatically recognises when a microphone/hydrophone is connected.



It will briefly show the name of the microphone/hydrophone (e.g. **EM 350**; two-part display: first **EM**, then **350**).

- Signal, *here: 1247*
- Microphone/hydrophone connected, *here: EM*

The status message will then disappear. The device is back in measuring mode.

### 5.6.3 Listening to noise

The noise can be heard on the **RT 300** through headphones. The headphones are switched on and off using the loudspeaker key. The following applies:

Headphones	Loudspeaker symbol	Bar graph
Switched on	Not visible	Volume
Switched off	Visible	Reception quality

**Requirements** for listening to noise:

- Headphones connected
- Microphone/hydrophone connected
- Headphones switched on

### 5.6.3.1 Adjusting the volume

The volume can be adjusted any time during listening using the arrow keys.

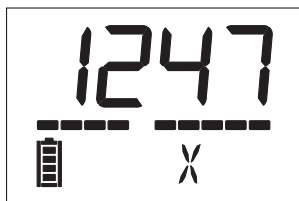

The currently selected volume is symbolised by the missing segment.

- *Here*: moderate volume selected

- Press the **arrow-up key** to **increase** the volume or the **arrow-down key** to **reduce** the volume.

The missing segment of the volume display will move to the left or right.

### 5.6.3.2 Hearing protection function

The **RT 300** features a hearing protection function to protect the user. On the headphones this:

- **limits** noise to a certain volume if a preset limit is exceeded.
- **switches off** noise if the preset limit is **considerably** exceeded.



The **hearing protection symbol** appears on the display when the sound is switched off.

#### Listening again

If the sound has been switched off by the device (hearing protection symbol visible) there are two ways to start listening again:

- Reduce the volume
- Wait until the noise falls back down below the limit again

## Noise protection limits (levels)

Level	Limit [dB]
0	–
1	95
2	85

If **level 0** is set, the hearing protection is **switched off** (as delivered).



### CAUTION!

- Set the hearing protection function to level 1 or 2 to protect yourself against loud noises.
- 

## Adjusting the hearing protection

1. Hold down the loudspeaker key for 3s.



The current hearing protection level setting will appear.

- *Here:* level 0
- Status message **PRO**

2. Using the arrow keys set the desired level for the hearing protection function.
3. Press the ON/OFF key to save the setting. The device will return to measuring mode.

### 5.6.3.3 Filtering noise

The noise that can be heard through the headphones can be filtered. The filters limit the range of the audible frequencies. By systematically changing the filters you can often improve the individual perception of the noise.

---

**Note:**

The filter does not affect the type or volume of data saved by the **RT 300** or the correlation result.

---

**Filter limits**

Frequency [kHz]
0.2 – 1
1 – 3
0 – 0.2
0 – 0.5
0 – 1 *
0 – 5 **

\* **HY 300** factory settings

\*\* **EM 350** factory settings

**Adjusting the filter**

1. Press the filter key. The headphones are switched on automatically (if they were switched off).



The currently set filter is shown.

- *Here:* Filter **0 – 5 kHz**
- **Filter symbol** flashes

2. Set the desired filter using the arrow keys.
3. Press the ON/OFF key OR the filter key to apply the setting. The device will return to measuring mode.

---

**Note:**

The selected filter is not saved when the device is switched off.

---

## 5.6.4 Replacing disposable/rechargeable batteries

If the **RT 300** is powered by disposable batteries, they must be changed as soon as the battery symbol on the display starts to flash. Rechargeable batteries (accus) can also be changed if required. After replacing the disposable/rechargeable batteries, you must set the type.

---

### **Note:**

Used batteries must be disposed of carefully using **appropriate local recycling facilities**.

---

### 5.6.4.1 Replacing the batteries

The battery compartment is under the housing base. To unscrew the housing base you will need a large screwdriver or another tool (e.g. metal disc from round magnet on microphone, coin).

---

### **Note:**

The housing base must be correctly lined up after you have changed the batteries so that it can be screwed back on again. This is easier if you attach the **carrying handle lengthways** before unscrewing the housing base and do not remove it when replacing the batteries.

---

1. Loosen the two screws securing the housing base. Remove the screws by repeatedly turning them a short way in alternation; this ensures that the housing base does not twist.
2. Remove and replace the batteries (disposable or rechargeable). Ensure that the batteries are inserted with the correct polarity (negative terminal to spring / positive terminal to metal strip).
3. Replace the housing base and line it up so that the screws can be screwed into the thread. Retighten the screws alternately.

### 5.6.4.2 Setting the type

#### ... following battery replacement (section 5.6.4.1)

1. Hold down the ON/OFF button until the start screen appears.

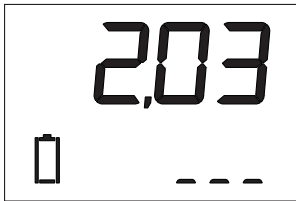

The following information will be displayed:

- Version number, *here*: **2.03**
- Battery symbol (empty)
- Type of power supply not recognised (dashes)

#### ... following error message F042

1. Hold down the filter key.

In both cases wait until the following image appears on the display:

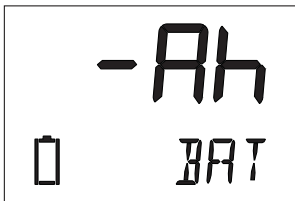

The battery symbol and **BAT** flash alternately.

2. Using the arrow keys set the type of battery in use.

Setting	Type	Capacity [Ah]
<b>BAT</b>	Disposable battery	–
<b>5 Ah</b>	Rechargeable battery	5
<b>6 Ah</b>		6
<b>7 Ah</b>		7
<b>8 Ah</b>		8
<b>9 Ah</b>		9
<b>10 Ah</b>		10
<b>11 Ah</b>		11
<b>12 Ah</b>	12	



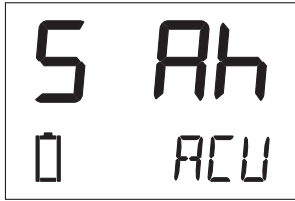

Display with selected battery type

- *Here:* rechargeable battery type **5 Ah**

3. Press the ON/OFF key to save the setting. The device will return to measuring mode.

Rechargeable batteries must be charged before you use the **RT 300** again (see section 5.6.5).

### 5.6.5 Charging the batteries

If the **RT 300** is powered by rechargeable batteries, they must be recharged as soon as the battery symbol on the display starts to flash.

The device must be **switched off** when the batteries are being recharged.

---

#### Note:

If the **RT 300** is switched on when the jack is plugged into the charging socket, the batteries will not charge. Instead, the device will be powered externally and is ready for use (see also section 5.6.5.3).

---

1. Plug the AC/DC adapter plug into the charging socket of the **RT 300**. Charging starts automatically. Two opposite LEDs on the **RT 300** flash every two seconds (see section 5.1.4).



The **charging start screen** will appear. The following information will be displayed:

- Version number, *here*: **1.02**
- Battery symbol (empty)
- Battery type display **ACU** (rechargeable battery)

2. Wait a moment.

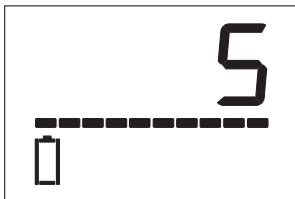

Charging begins.

- Duration of charging process [h], *here*: **5**
- The bar display will run continually from left to right.
- Battery symbol; initially empty, number of visible segments will increase with charging

The time until the end of charging will be counted down.

### 5.6.5.1 End of charging

The batteries are fully charged when the flash of the LEDs changes to a short double flash (see section 5.1.4).

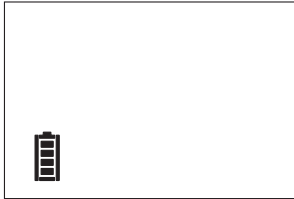

The display shows the battery symbol (full).

- Remove the AC/DC adapter plug from the charging socket of the **RT 300**.

### 5.6.5.2 Charging problems

Any problems encountered when charging the batteries are signalled by status messages (see section 10.2.2).

Message	RT 300 response	Corrective action
<b>T 0</b>	Charging aborted	<ul style="list-style-type: none"> <li>• If possible: change the ambient temperature</li> </ul>
<b>T45</b>		
<b>10 V</b>	Charging voltage reduced to 10V, charging time doubles	–

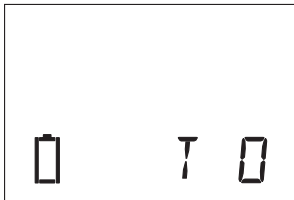

The display shows problems during charging.

- *Here*: status message **T 0**, i.e. battery temperature when charging below 0 °C

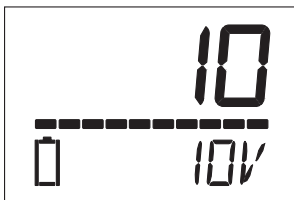

- *Here*: status message **10V**, i.e. charging voltage reduced to 10 V
- Charging time doubles, *here*: **10 h**

### 5.6.5.3 Changing between charging and external power supply

During the charging process the **RT 300** can be switched to measuring mode with an external power supply.

1. Press the ON/OFF key.

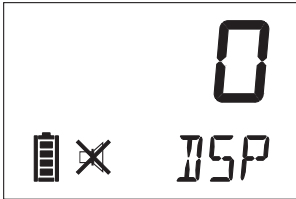

The device switches on.

- **DSP** status message (powered via AC/DC adapter)

2. Wait a moment until the device returns to measuring mode.

### Continuing charging

- Press the ON/OFF key again. The device switches back to charging (provided the AC/DC adapter is still connected).

The process will take a while. The device switches off in between, but comes back on again.

### 5.6.6 Reception quality display

During measurement the **RT 300** bar display indicates the quality of the radio connection. The more segments that are visible on the bar display, the better the reception quality.

**Conditions** for reception quality display:

- **RX 300** radio receiver connected
- Headphones switched off

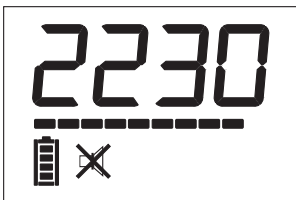

Display showing reception quality

- *Here*: very good reception (one segment missing)

### 5.6.7 Synchronicity display

The radio transmitters used for a measurement must be synchronised to ensure a correct measurement.

**The radio transmitters are synchronised via the computer.**

Each individual device will show whether the radio transmitters are synchronised.

Synchronisation symbol	RT 300 Radio Transmitter	
	flashes	not synchronised
	not visible	synchronised

### 5.6.8 Switching on the light (display and microphone)

The display lighting on the **RT 300** and the illumination of the measurement location by LEDs on the **EM 350** are linked.

- Press the light key to illuminate the display and to switch on the LEDs on the **EM 350**.

The light will stay on for **30s** and will then go out automatically.

- Press the light key again before the 30s lapse if you want to switch off the light deliberately.



#### **CAUTION!**

The LEDs on the microphone have a high intensity.

- Never shine the microphone light into the eyes.
-

## 6 RX 300 Radio Receiver

### 6.1 Function and setup

The **RX 300 radio receiver** synchronises the radio transmitters and relays the data from the transmitters to the computer. As such, the **RX 300** is the link between the transmitters and the computer.

The **RX 300** does not have any controls. It is ready for use as soon as it receives power from the computer. To this end, the jack of the USB cable must be plugged into the appropriate socket in the housing.

You will find an overview and all the part names of the **RX 300** in the back cover (figs. 10 and 11).



Fig. 7: **RX 300 radio receiver** with connected USB cable and magnet

### 6.1.1 LED

An LED is fitted in the housing of the **RX 300** above the USB socket. The LED flashes red.

Flash rate	Description
Steadily flashing every 1s	Receiver ready for use, no radio connection to the transmitters
Light permanently on	Radio connection to at least one transmitter
Light permanently on, flickering	Data transfer between receiver and transmitter

### 6.2 Setup/mounting

The **RX 300** can stand alone when the **magnet** is screwed on. The magnet prevents the device from toppling on metal surfaces.



#### **WARNING!**

The magnet is very powerful.

- Persons with a pacemaker should not come close to the **RX 300** radio receiver.
  - The magnet must be kept away from electronic storage media (diskettes, hard drives, credit cards, etc.), monitors (PC, TV) and clocks.
  - If the **RX 300** is mounted on the roof of a vehicle using a magnet, the vehicle must not be moved.
-

### 6.3 Power supply

The **RX 300** is powered via the computer. This means that a computer must always be connected for the **RX 300** to receive data.

### 6.4 Changing the aerial

The aerial is fitted to the device with a screwed joint. Please note when changing the aerial:

- The screwed joint must always be **clean and dry**.
- **Hand-tighten** the aerial. Do not use any tools to tighten it.

Note: The aerials of the **RTX 300** and **RT 300** are identical.

### 6.5 Advice for use

- Basic rule for using the **RX 300**:

**The freer and higher the RX 300 is mounted, the better the data reception.**

In other words, high, flat surfaces are ideal (e.g. vehicle roof).

- If the vehicle is to be used to mount the **RX 300**, always place the device on the roof. Do not attach the receiver to the side of the vehicle.
- The magnet is rubberised to prevent damage to the underlying surface (e.g. damage to paintwork). Always keep the **magnet clean**. If necessary, wash down with water.



## 7

### Stand

The stand ensures that the **RT 300** is positioned securely and is at the required height for optimal data transmission. The **RT 300** must always be secured to the stand during the measurement.

The stand, **RT 300** and microphone can all be easily transported together whilst assembled by the top end of the telescopic tube.



#### **CAUTION! Risk of trapping fingers!**

Small magnets secure the three parts of the stand base.

- Always keep your fingers away from moving parts of the stand.
- 

#### **Advice for setup**

- Always fully extend the telescopic tube of the stand.
- The **RT 300** must be as vertical as possible on the stand. If necessary change the angle between the stand base and telescopic tube to even out any dips in the underlying surface.



Fig. 8: Stand with **RT 300** and **EM 350**

## 8 Performing a Correlation Measurement

### 8.1 Suitable measurement locations

Any accessible point in the pipe network is suitable as a measurement location, provided the leak generates a measurable signal there. This can, however, only be verified through the measurement itself.

Accessible points include, for example, slide gates, hydrants and house connection valves. A radio link or line-of-sight between the measurement locations is not required.

	Can be connected to
<b>EM 350</b>	<ul style="list-style-type: none"><li>● Pipeline</li><li>● Hydrant</li><li>● House connection valve</li><li>● Slide gate</li></ul>
<b>HY 300</b>	<ul style="list-style-type: none"><li>● Hydrant</li><li>● House connection</li><li>● Flushing equipment</li><li>● Fan</li></ul>

If you intend to use the **EM 350** and attach it with a magnet, select an appropriate location that provides the most surface contact for the magnet.

### 8.2 Requirements

#### 8.2.1 Equipment

To perform a correlation measurement with the **SeCorr 300** you will need (at minimum):

- 2 **EM 350** microphones or 2 **HY 300** hydrophones
- 2 **RT 300** radio transmitters
- 2 stands
- 1 **RX 300** radio receiver
- 1 computer

---

**Note:**

The radio transmitters and receivers are calibrated by the manufacturer. If you are using more than one **SeCorr 300**, only the **RT 300** and **RX 300** which are part of the one system may be combined.

- If necessary, mark the appliances which are part of the same system to prevent mix-ups.

When recording noise, you must use only microphones or only hydrophones. It is not possible to combine a microphone and a hydrophone in the same application.

---

### 8.2.2 Required data

To calculate the leak position using the **SeCorr 300 software**, you must have the following information about the **pipeline**:

- Position
- Material
- Special features in the piping (e.g. bends, house connections, pressure regulators)
- Length of the (water-filled) pipeline between the measurement locations

Please note that it is **not the distance** (i.e. the shortest connection) between the measurement locations, but rather the **actual length of the pipeline** that is required.

### 8.3 Setting up the measuring section

Once all the conditions for performing a measurement have been met (see section 8.2), you can start up the system.

1. Set up a stand close to the computer for each measurement location (see section 7).
2. Attach an **RT 300** to each stand.
3. Switch on all **RT 300s**.
4. Switch on the computer.
5. Connect the **RX 300** to the computer.

6. Set up the **RX 300** . Follow the instructions in sections 6.2 and 6.5.
7. Test the system. Launch the **SeCorr 300 software** on the computer. The connection to the **RX 300** will be established automatically and the **RT 300** will be synchronised.  
  
You will be informed of any problems that occur by a corresponding error message on the computer/display of the **RT 300**.
8. Carry the stands (with the **RT 300**) and one microphone/hydrophone to the measurement locations.

**At each measurement location:**

**... when measuring with a microphone**

1. Attach the microphone to the measurement location.
  - Despite the strong magnetic force **carefully** place the microphone at the measurement location.
  - Install the microphone at the measurement location as **up-right** as possible. The maximum permitted tilt is 45°.
2. Connect the microphone to the **RT 300**.
3. Test the microphone by connecting headphones to the **RT 300**.

If you can hear noises through the headphones (see section 5.6.3), the microphone is working.

**... when measuring with a hydrophone**

1. Flush the measurement location.
2. Disinfect all parts of the **HY 300** that can come into contact with drinking water.



**CAUTION!**

- To disinfect the **HY 300**, use only disinfectants approved for use with drinking water.
-

3. Attach the hydrophone to the measurement location.
    - Use an adapter if necessary.
    - Seal off the connection.
    - Do this with the aid of the rotary tool if necessary.
- 

**Note:**

When using the **adapter for underground hydrants**, you must only hand-tighten the hydrophone – adapter connection.

---

4. Open the fitting completely.
5. Check all connections between the hydrophone, measurement location and any adapter used for leak-tightness. Leaky connections cause interference noises that can falsify the measurement result.
6. Vent the measurement location using the ventilation valve on the hydrophone.
7. Connect the hydrophone to the **RT 300** using the hydrophone cable.
8. Test the hydrophone by connecting headphones to the **RT 300**.

If you can hear noises through the headphones (see section 5.6.3), the hydrophone is working.

Once you have set up all the measurement locations as described, the system is ready to start measuring. Signals are already being picked up and recorded. Continue to work on the computer.

9. Click on the **new measurement** button. The **measurement guidelines** window will appear.
10. Enter the required data.
11. Confirm your entries with **OK**. The **measuring dialogue** and the **time selection** window will appear.

Further use of the **SeCorr 300 software** is explained in separate operating instructions.

## 9 Troubleshooting

If you encounter problems when working with the **SeCorr 300**, you will generally receive an error message on the computer from the **SeCorr 300 software**. This states the cause of the fault and repair options.

The following sections explain problems that can be attributed to the individual system components.

### 9.1 Problems with the RT 300

#### 9.1.1 Device not ready for use

Description of alert	Cause/corrective action
LEDs not flashing	<ul style="list-style-type: none"><li>• Battery empty &gt; change/recharge batteries</li><li>• Device faulty &gt; send device to SEWERIN Service</li></ul>

#### 9.1.2 Status messages during the charging process

**Charging** problems are indicated by a status message: section 10.2.2 explains what the status messages mean.

#### 9.1.3 Error codes

The **RT 300** displays internal errors on the display with an error code (see table).



- Error code, *here*: **F042**
- Status message **ERR** (error)

<b>Error code</b>	<b>Cause</b>	<b>Corrective action</b>
<b>F014</b>	Device malfunction	<ul style="list-style-type: none"> <li>● Only through SEWERIN Service</li> </ul>
<b>F042</b>	Battery requires charging	<ul style="list-style-type: none"> <li>● Insert rechargeable</li> </ul> OR <ul style="list-style-type: none"> <li>● Replace battery (instead of charging)</li> </ul> OR <ul style="list-style-type: none"> <li>● Set correct battery type (see section 5.6.4.2)</li> </ul>
<b>F055</b>	Device malfunction	<ul style="list-style-type: none"> <li>● Only through SEWERIN Service</li> </ul>
<b>F062</b>	Battery missing or inserted wrong way round	<ul style="list-style-type: none"> <li>● Insert battery</li> <li>● Check polarity</li> </ul>
<b>F063</b>	External voltage less than 10V	<ul style="list-style-type: none"> <li>● Device will automatically halve charging voltage (display <b>10V</b>)</li> </ul> If malfunction reoccurs: <ul style="list-style-type: none"> <li>● AC/DC adapter faulty &gt; replace AC/DC adapter</li> <li>● Replace vehicle cable with AC/DC adapter</li> </ul>
<b>F064</b>	Charging electronics error	<ul style="list-style-type: none"> <li>● Only through SEWERIN Service</li> </ul>
<b>F200</b>	Device malfunction	<ul style="list-style-type: none"> <li>● Switch on device again</li> <li>● Fault can be ignored if it occurs occasionally</li> <li>● If it occurs regularly contact SEWERIN Service for help.</li> </ul>
<b>F201</b>	Communication error	<ul style="list-style-type: none"> <li>● Temporary error message</li> <li>● Fault can be ignored if it occurs occasionally</li> <li>● If it occurs regularly contact SEWERIN Service for help.</li> </ul>
<b>F210</b>	Device malfunction	<ul style="list-style-type: none"> <li>● Only through SEWERIN Service</li> </ul>
<b>F211</b>		
<b>F212</b>		
<b>F213</b>		
<b>F214</b>		
<b>F215</b>		

## 9.2 Problems with the RX 300

Description of alert	Cause/corrective action
LED not flashing	<ul style="list-style-type: none"><li>• Check plug connection (cable) on <b>RX 300</b> and on computer</li><li>• Exit software and restart</li><li>• Device faulty &gt; send device to SEWERIN Service</li></ul>

## 9.3 Problems with the RX 300 – RT 300 radio connection

The most common reason for problems with exchanging data between the **RX 300** and **RT 300** is the quality of the radio connection.

---

### Note:

The radio connection is only required for data transmission. A radio connection is not required for a correlation measurement.

---

Description of alert	Cause/corrective action
Bar display on <b>RT 300 screen</b> : only a few or no segments visible AND <b>SeCorr 300 software About transmitter</b> section: aerial symbol shows low signal strength; status bar, right: black square visible	<ul style="list-style-type: none"><li>• Check transmission path: are objects causing dark zones?</li><li>• Change position of <b>RT 300</b>, e.g. move to side, position higher up</li><li>• Set up <b>RT 300</b> close to <b>RX 300</b> for data transmission</li><li>• Change position of <b>RX 300</b>, e.g. move to side, position higher up</li></ul>



# 10 Appendix

## 10.1 Specifications and permitted operating conditions

### 10.1.1 RT 300 radio transmitter

#### Device data

Dimensions (H × Ø)	110 x 215 mm without aerial 110 x 410 mm with aerial
Weight	2.6 kg (with disposable batteries)
Material	Aluminium, anodised

#### Certificates

Certificate	Depends on model CE, FCC, IC
Marking	Depends on model Contains FCC ID: WSP860221 IC:7994A-860221)

#### Features

Display	LCD, transfective, 7-digit, 96 segments
Signal light	6 LEDs (rotating)
Interface	Sturdy, non-twist, coded sockets for: <ul style="list-style-type: none"><li>● Charging / external power supply</li><li>● Microphone</li><li>● Headphones (phone jack 6.3 mm)</li></ul>
Memory	40 min signal memory
Processor	Signal processing: 24 bit DSP Data processing: microcontroller
Operation	Membrane keypad with 6 keys

#### Operating conditions

Operating temperature	-10 °C – +40 °C
Storage temperature	-20 °C – +60 °C
Humidity	5 – 95 % r.h., non-condensing
Protection rating	IP64
Permitted operating environments	In air
Non-permitted operating environments	<ul style="list-style-type: none"><li>● Underwater</li><li>● In potentially explosive areas</li></ul>
Normal position of use	Vertical

## Data logging

Filter	Various filters for audio transmission
Sampling rate	12 kHz

## Data transmission

Transmission frequency	Depends on model DECT (1.88 – 1.9 GHz) 2.4 GHz
Radio range	> 800 m (free line-of-sight at height of 1 m)
Transmission band-width	0 – 5 kHz
Communication	Bi-directional radio data
Power	100 mW

## Power supply

Power supply	4 cells, type: mono D, either: rechargeable batteries: NiMH disposable batteries: alkaline or externally via charging cable/charger
Operating time, typical	Rechargeable batteries: 8 – 20 h (depending on type) Disposable batteries: > 25h
Operating voltage	5 – 6 V
Charging time	3 – 7 h (depending on type)
Charging temperature	0 – 40 °C
Charging voltage	12 V
Charging current	2.1 A
Charger	LD30-10000
Nominal capacity	4 – 12 Ah (depending on battery type)

## 10.1.2 RX 300 radio receiver

### Device data

Dimensions (W x D x H)	50 x 108 x 51 mm without aerial 50 x 300 x 51 mm with aerial
Weight	500 g
Material	Die-cast aluminium housing

### Certificates

Certificate	Depends on model CE, FCC, IC
Marking	Depends on model Contains: FCC ID: WSP860221 IC:7994A-860221)

### Features

Signal light	1 LED (function control)
Interface	Sturdy, non-twist socket for USB cable RX 300 (Connection to computer: USB 1.1 or higher, power consumption 500 mA)
Processor	Microcontroller

### Operating conditions

Operating temperature	-20 °C – +60 °C
Storage temperature	-30 °C – +80 °C
Humidity	95%, non-condensing
Protection rating	IP68
Permitted operating environments	Outdoors
Non-permitted operating environments	<ul style="list-style-type: none"><li>• In aggressive media</li><li>• In potentially explosive areas</li></ul>

### Power supply

Power supply	External via USB
Operating voltage	5 V, max. 500 mA

## Data transmission

Transmission frequency	Depends on model DECT (1.88 – 1.9 GHz) 2.4 GHz
Radio range	> 800 m (free line-of-sight)
Transmission bandwidth	0 – 5 kHz
Communication	Bi-directional radio data
Power	100 mW

### 10.1.3 EM 350 microphone

#### Device data

Dimensions (H × Ø)	123 x 45 mm (without cable)
Weight	1.1 kg (incl. cable)
Material	Stainless steel

#### Features

Interface	Digital
Processor	Signal processing ADC, 2 × 24 Bit

#### Operating conditions

Operating temperature	-20 °C – +80 °C
Storage temperature	-25 °C – +80 °C
Protection rating	IP68
Permitted operating environments	<ul style="list-style-type: none"><li>• Submersible to 1 m</li></ul>
Non-permitted operating environments	<ul style="list-style-type: none"><li>• In aggressive media</li><li>• In potentially explosive areas</li></ul>

#### Power supply

Power supply	Via RT 300
Operating voltage	5 V

#### Data transmission

Communication	Digital via cable with RT 300
---------------	-------------------------------

#### Detection

Sensitivity	Type 10 V/g (at 100 Hz)
-------------	-------------------------

#### 10.1.4 HY 300 hydrophone

Model	Stainless steel
Protection rating	IP68
Weight	700 g (without cable)
Dimensions (W× H)	55 × 115 mm
Thread	1"
Pressure	16 bar
Operating temperature	-20 °C – +80 °C
Storage temperature	-30 °C – +90 °C
Communication	Digital via cable with RT 300
Frequency band	0 – 3000 Hz
Processor	Signal processing: ADC, 2 × 24 Bit
Cable	<ul style="list-style-type: none"><li>• Separate</li><li>• Length: 2.8 m</li></ul>
Other	Digital microphone
Permitted operating environments	<ul style="list-style-type: none"><li>• Outdoors</li><li>• Submersible to 1 m</li></ul>
Non-permitted operating environments	<ul style="list-style-type: none"><li>• In liquids other than water</li><li>• In aggressive media</li><li>• In potentially explosive areas</li></ul>
Humidity	95%, non-condensing

### 10.1.5 Stand for RT 300

Model	Aluminium, zinc-coated steel
Weight	3.1 kg
Dimensions (W× H)	580 × 870 mm
Mounting	Quick-connect for RT 300
Other	<ul style="list-style-type: none"><li>• Adjustable telescopic rod tilt angle (15° increments)</li><li>• Microphone holder</li></ul>

### 10.1.6 SeCorr 300 software





Operating system:	Windows 2000, XP, Vista
RAM	Minimum 512 MB (1024 MB recommended)
Processor:	Minimum 1.2 GHz (1.8 GHz recommended)

### 10.1.7 SeCorr 300 system (system features)

Range:	<ul style="list-style-type: none"><li>• Built-up area: approx. 200 m</li><li>• With line-of-sight: approx. 800 m</li></ul>
Number of RT 300s that can be connected:	2

## 10.2 RT 300 display

### 10.2.1 Symbols

Symbol	Description
	Battery symbol, full (left) or empty (right)
	Loudspeaker symbol (always crossed out)
	Filter symbol
	Synchronisation symbol
	Hearing protection symbol

### 10.2.2 Status messages

Message	Description
<b>ACU</b>	Powered by rechargeable battery (accumulator)
<b>BAT</b>	Powered by disposable battery
<b>DSP</b>	Powered by AC/DC adapter
<b>EM ... 350</b>	EM 350 microphone detected
<b>ERR</b>	Error code display
<b>HY ... 300</b>	HY 300 hydrophone detected
<b>KHZ</b>	Kilohertz unit [kHz]
<b>PRO</b>	Adjusting the hearing protection
<b>T 0</b>	Battery temperature when charging below 0 °C
<b>T45</b>	Battery temperature when charging above 45 °C
<b>10 V</b>	Charging voltage reduced to 10 V due to under-voltage (charging time doubles)

### 10.3 Accessories

Part	Order number
RT 300 case	ZD32-10000
RX 300 case	ZD33-10000
HY 300 hydrophone equipment set	HY30-S0001
AC/DC adapter M300 12 V = /5 A EURO	LD30-10000
Vehicle cable M300	ZL08-10100
Vehicle cable M300 mounting	ZL08-10200
K3 headphones	EZ13-11000
M10 main pipe adapter	ZM02-10000
M10 house connection adapter	ZM04-10000
Cover hammer	7222-0001
Magnetic cover lifter	7222-0002
8-pin hydrophone cable	HY30-Z0100
RX 300 vehicle aerial	RX30-Z0400

Other accessories are available for the product. Please contact our SEWERIN sales department for further information.



#### 10.4 **Declarations of conformity**

Hermann Sewerin GmbH hereby declares that the **RT 300** and the **RX 300** fulfil the requirements of the following directive:

- 1999/5/EC

The complete declaration of conformity can be found online.

#### 10.5 **Advice on disposal**

The European Waste Catalogue (EWC) governs the disposal of appliances and accessories.

<b>Description of waste</b>	<b>Allocated EWC waste code</b>
Device	16 02 13
Disposable battery, rechargeable battery	16 06 05

#### **End-of-life equipment**

Used equipment can be returned to Hermann Sewerin GmbH. We will arrange for the equipment to be disposed of appropriately by certified specialist contractors free of charge.

# 11 Index

## A

Aerial  
Safety information 4

## B

Backlight 29  
Bar graph 19, 26, 28  
Battery symbol 18

## C

Carrying handle 16  
Changing the aerial 17, 32  
Charging 26  
Changing to external power supply 28  
End of charging 27  
Problems 27  
Colour coding 14  
Computer 7  
Connectors 16  
Correlation measurement  
Equipment 34  
Required data 35  
Requirements 34

## D

Disposable battery  
Replacing 23  
Setting the type 24

## E

EM 350  
Backlight 29  
Cable 11  
Connection options 34  
Function 9  
Housing 10  
Installation 36  
LED 10  
Magnet 11  
Ranges of use 9  
Setup 9  
Error codes 38

## F

Filtering 21  
Adjusting the filter 22  
Limits 22  
Filter key 22  
Flash rate 14, 31

## H

Hearing protection  
Limits (levels) 21  
Setting 21  
Hearing protection function 20  
Horseshoe magnet 11  
HY 300  
Connection options 34  
Function 9  
Hydrophone housing 12  
Installation 36  
Ranges of use 9  
Setup 12  
Hydrophone cable 12  
Hydrophone HY 300 see HY 300

## L

LED 10, 14, 31  
Light key 29  
Listening 19  
Loudspeaker key 19, 21

## M

Measurement see Correlation measurement  
Microphone EM 350 see EM 350

## P

Purpose 1

## R

Radio connection  
Problems with 40  
Reception quality 28  
Rechargeable battery  
Charging 26

- Replacing 23
- Setting the type 24
- Round magnet 11
- RT 300
  - Carrying handle 16
  - Changing the aerial 17
  - Connections 14
  - Display 15
  - Display illumination 29
  - Disposable battery 17
  - Function 13
  - Keys 15
  - LED 14
  - Marking 13
  - Mounting 15
  - Plugging in the microphone 19
  - Power supply 17
  - Problems with 38
  - Rechargeable battery 17
  - Replacing disposable/rechargeable batteries 23
  - Safety information 5
  - Setup 13, 15
  - Sockets 14
  - Switching on 18
  - Transport 16
- RT 300 radio transmitter see RT 300
- RT 300 radio transmitter RX 300 see RX 300
- RX 300
  - Advice for use 32
  - Changing the aerial 32
  - Function 30
  - LED 31
  - Mounting 31
  - Power supply 32
  - Problems with 40
  - Setup 30, 31

## **S**

- SeCorr 300
  - Components 6
  - Functional principle 8
  - Overview 6
- Setting up the measuring section 35
- Stand 33
- Status messages 47
- Symbols 47
- Synchronicity 29

System SeCorr 300 see SeCorr 300

## **U**

- Use
  - Improper use 3
  - Intended 3

## **V**

- Volume 20

# Funkempfänger RX 300

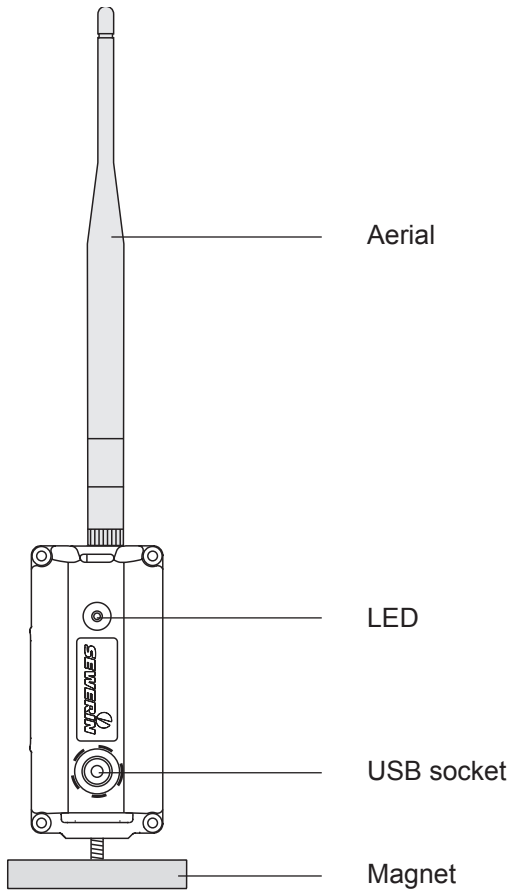

Fig. 9: **RX 300 radio receiver**, front view with aerial

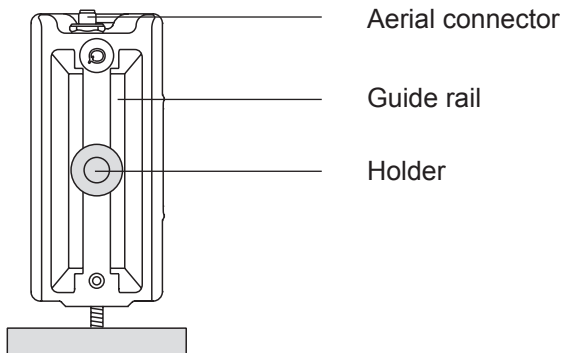

Fig. 10: **RX 300 radio receiver**, rear view without aerial



Hermann Sewerin GmbH

Robert-Bosch-Straße 3  
33334 Gütersloh, Germany  
Tel.: +49 5241 934-0  
Fax: +49 5241 934-444  
[www.sewerin.com](http://www.sewerin.com)  
[info@sewerin.com](mailto:info@sewerin.com)

SEWERIN SARL

17, rue Ampère – BP 211  
67727 Hoerdts Cedex, France  
Tél. : +33 3 88 68 15 15  
Fax : +33 3 88 68 11 77  
[www.sewerin.fr](http://www.sewerin.fr)  
[sewerin@sewerin.fr](mailto:sewerin@sewerin.fr)

SEWERIN IBERIA S.L.

Centro de Negocios "Eisenhower"  
Avenida Sur del Aeropuerto  
de Barajas 28, Of. 2.1 y 2.2  
28042 Madrid, España  
Tel.: +34 91 74807-57  
Fax: +34 91 74807-58  
[www.sewerin.es](http://www.sewerin.es)  
[info@sewerin.es](mailto:info@sewerin.es)

Sewerin Ltd

Hertfordshire  
UK  
Phone: +44 1462-634363  
[www.sewerin.co.uk](http://www.sewerin.co.uk)  
[info@sewerin.co.uk](mailto:info@sewerin.co.uk)

Sewerin Sp.z o.o.

ul. Twórcza 79L/1  
03-289 Warszawa, Polska  
Tel.: +48 22 675 09 69  
Faks: +48 22 486 93 44  
Tel. kom.: +48 501 879 444  
[www.sewerin.pl](http://www.sewerin.pl)  
[info@sewerin.pl](mailto:info@sewerin.pl)